

FALCON LOCK CO.

HEAVY DUTY AND SUPER DUTY LOCKS

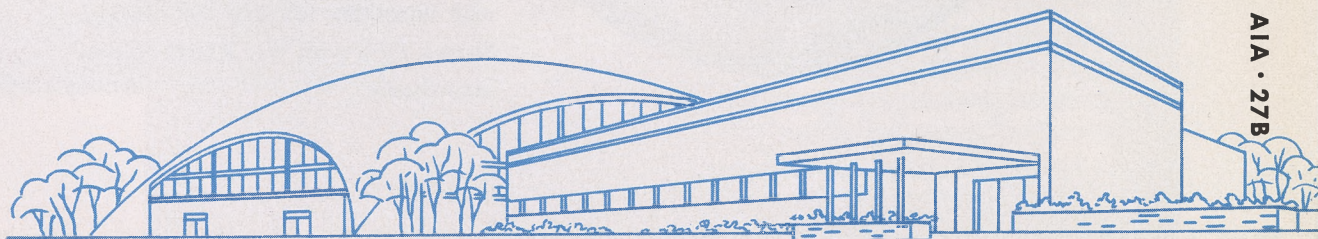
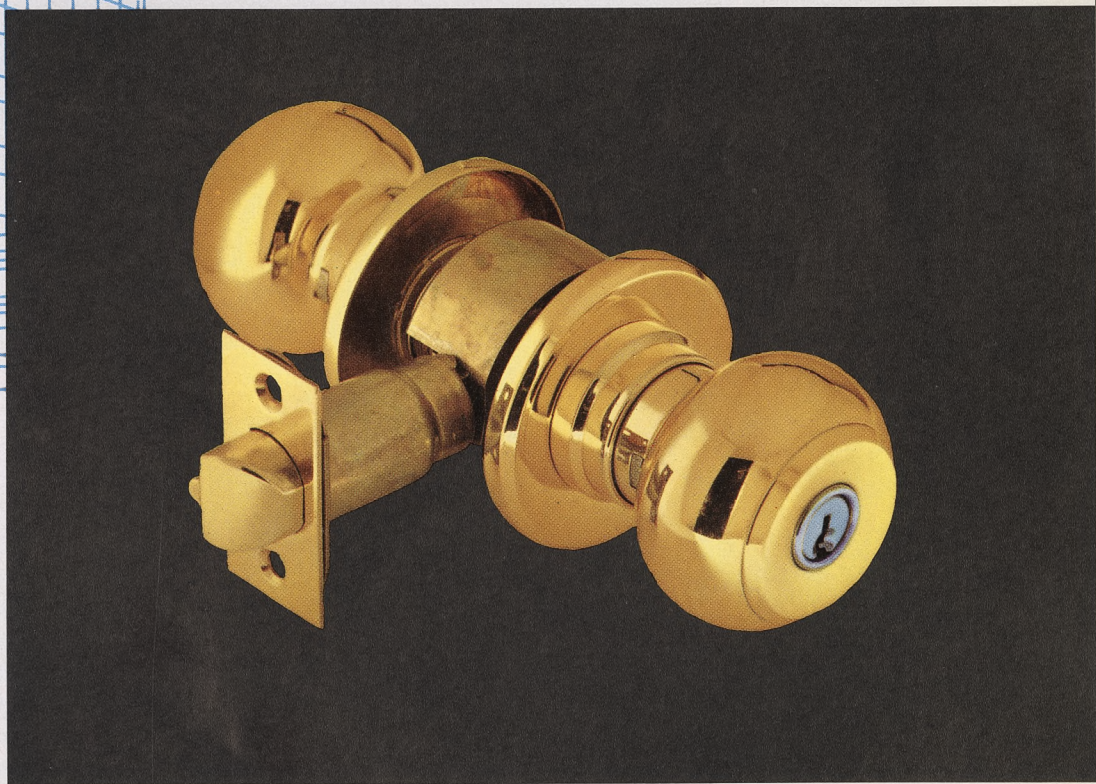

FALCON

SUPER DUTY LOCKS MEET EVERY ARCHITECTURAL REQUIREMENT

There is a Falcon Super Duty Lock for every commercial, institutional and custom residential need. Conceived and engineered for today's finest buildings, Falcon Locks are available in a wide range of styles, finishes and functions. The Specification of Falcon Super Duty Locks assures the architect and builder of quality and trouble-free service.



The Falcon Key-in-Knob Entrance lock in Satin Chrome provides beauty and durability for any installation. Shown here with No. X1642 Round escutcheon.

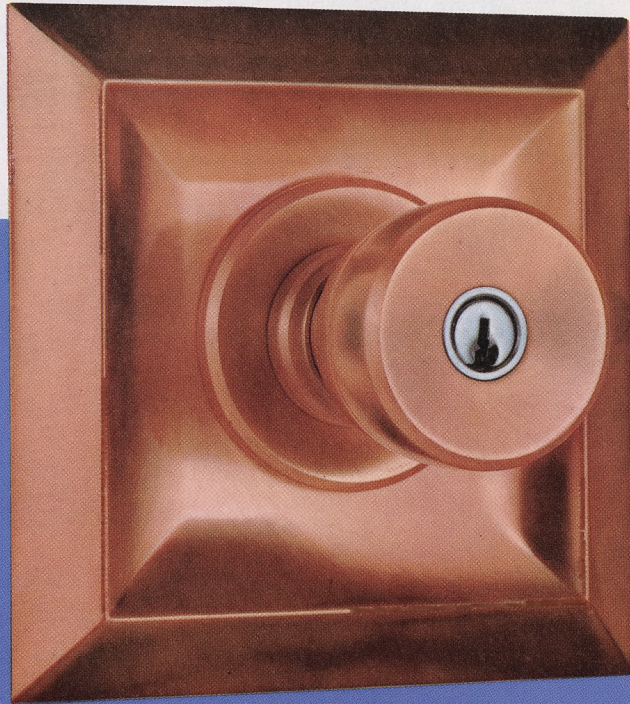

The rich appeal of satin bronze is vividly demonstrated in this Key-in-Knob Entrance lock combined with a No. X1637 Square Escutcheon. It may be mounted in square or diamond position.

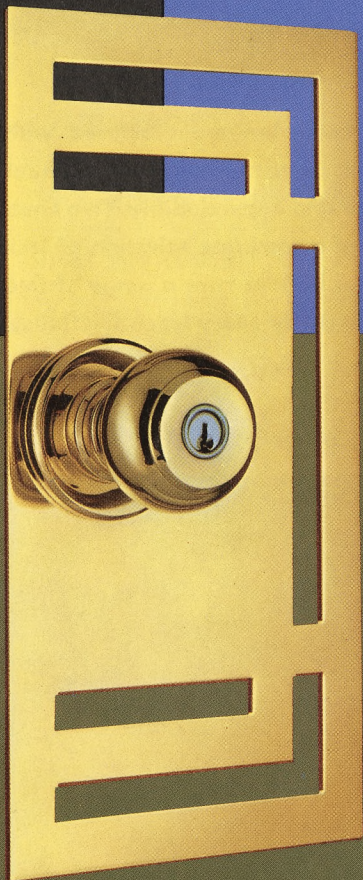

The massive and striking appearance of the No. X1636 Tall Square Escutcheon lends an impressive background to this Falcon Entrance Lock. May be used with all backsets on single or double door installations.



Whether used on single doors or in pairs on double door applications, the No. X1635 Half Round Escutcheon with Falcon Key-in-Knob lock makes a favorable impression. It is equally attractive with all Falcon knob styles and in all finishes.

FALCON

"X" SERIES LOCKS



CROWN ROYAL

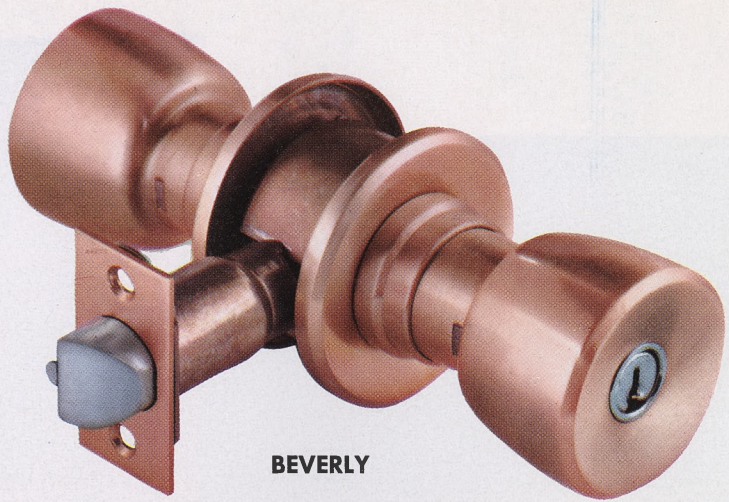

BEVERLY

Falcon "X" Series Locks are manufactured with extra heavy steel and brass mechanism throughout for maximum service and dependability. Two knob styles, as shown, and a complete selection of lock functions, provide the builder with a range of fine quality, super duty locks for every type of building.

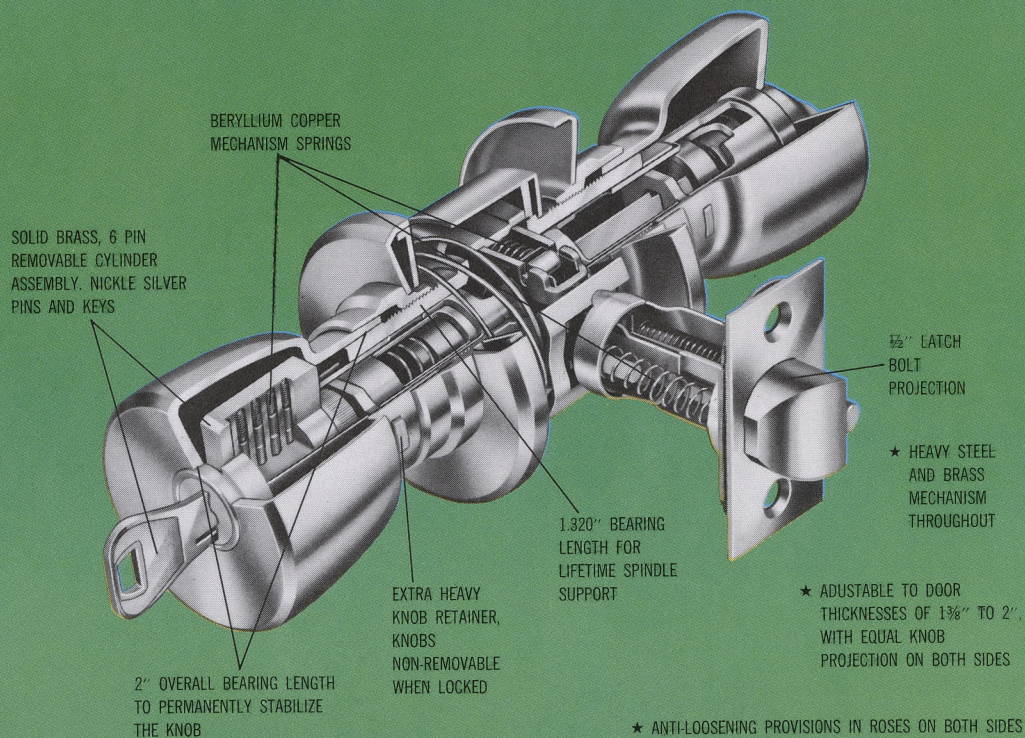



LOCK SELECTOR

The lock selector chart below provides a convenient guide to the correct lock function for any door. It will aid in selecting the locks necessary for proper security and convenience of door openings in all commercial buildings.

 **PLAIN KNOB**
No locking mechanism.

 **PUSH BUTTON**
Button pushed inward locks door. Turn of inside knob releases button — unlocks door.

 **TURN BUTTON**
Quarter turn to right locks door. Turning button to the left unlocks door.





























 **UNIVERSAL BUTTON**
Push button inward for temporary security. Turning button to right gives permanent security. Combines operations of push and turn buttons.

 **EMERGENCY RELEASE**
Provides privacy, but in emergency can be opened without special key.



































 **THUMB TURN**
Used instead of plain knob on inside of closet door or where knob would ordinarily be out of sight.

 **PIN TUMBLER KEY UNIT**
Provides unlimited key changes. Can be master-keyed, and grand-mastered as desired.













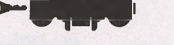

 **INDICATOR KEYWAY**
Pin tumbler keyway with visual Occupancy Indicator pin.

TYPE OF LOCK	2 3/4" BACKSET	5" BACKSET	2 3/8" BACKSET	KNOB OUTSIDE	LOCK SILHOUETTE	KNOB INSIDE	OPERATION
PASSAGE LATCHSET	X 101	X 102	X 100				Latch bolt by knob from either side. Both knobs always free.
EXIT DOOR LATCHSET	X 141 DL	X 142 DL	X 140 DL				Latch bolt by inside knob only. Outside knob always rigid. Deadlocking latch.
CLOSET DOOR LATCHSET	X 151	X 152	X 150				Latch bolt by knob from outside and by thumb turn inside at all times.
CONNECTING ROOM OR EXIT DOOR LATCHSET	X 161 DL	X 162 DL	X 160 DL	Blank plate			Latch bolt by inside knob at all times. Non-removable blank plate outside. Deadlocking latch.
PATIO AND INNER OFFICE DOOR LOCK	X 201 DL	X 202 DL	X 200 DL				Latch bolt by knob from either side, except when outside knob is locked by locking button in inside knob. Inside knob is always free. Rotating inside knob or closing door automatically releases locking button and outside knob. Deadlocking latch.
KEYLESS COMMUNICATING DOOR LOCK	X 211 DL	X 212 DL	X 210 DL				Latch bolt by knob from either side, except when locked by locking buttons. Locking button in each knob locks or unlocks opposite knob. Each locking button must be manually returned to unlocked position to release opposite knob. Deadlocking latch — (Note: This lock should not be used on rooms to which there is no other entrance.)
KEYLESS EXIT DOOR LOCK	X 221 DL	X 222 DL	X 220 DL				Latch bolt by knob from either side, except when outside knob is locked by locking button in inside knob. Inside knob is always free. Locking button must be manually returned to unlocked position to release outside knob. Deadlocking latch.
TWIN COMMUNICATING DOOR LOCK	X 241 DL	X 242 DL	X 240 DL				Latch bolt by knob from inside and by thumb turn outside, except when thumb turn is locked by locking button in inside knob. Inside knob always free. Deadlocking latch.
PRIVACY LOCK FOR BATH & BEDROOM DOORS	X 301	X 302	X 300				Latch bolt by knob from either side, except when outside knob is locked by locking button in inside knob. Emergency release in outside knob. Rotating inside knob or closing door automatically releases locking button and outside knob.
CLOSET DOOR LOCK	X 311 DL	X 312 DL	X 310 DL				Latch bolt by knob from outside and by thumb turn inside, except when outside knob is locked by key in outside knob. Inside thumb turn always free. Deadlocking latch.





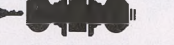

















NOTE: DL AFTER A CATALOG NUMBER INDICATES "DEADLOCKING LATCH" IN ABOVE CHART.

TYPE OF LOCK	2¾" BACKSET	5" BACKSET	2¾" BACKSET	KNOB OUTSIDE	LOCK SILHOUETTE	KNOB INSIDE	OPERATION
CLOSET DOOR LOCK	X 321 DL	X 322 DL	X 320 DL				Latch bolt by key from outside and by thumb turn inside. Outside knob always rigid. Inside thumb turn always free. Deadlocking latch.
CONNECTING ROOM OR EXIT DOOR LOCK	X 331 DL	X 332 DL	X 330 DL	Blank plate			Latch bolt by knob from inside, except when inside knob is locked by key in inside knob. Non-removable blank plate outside. Deadlocking latch.
CONNECTING ROOM OR EXIT DOOR LOCK	X 341 DL	X 342 DL	X 340 DL	Blank plate			Latch bolt by key from inside knob. Inside knob always rigid. Non-removable blank plate outside. Deadlocking latch.
PUBLIC ENTRANCE DOOR LOCK WITH LATCH HOLD BACK FEATURE	X 351 DL	X 352 DL	X 350 DL				Latch bolt by knob from either side, except when outside knob is locked by key in inside cylinder. Latch bolt may be retracted by key in outside cylinder or by knob from inside when outside knob is locked. Key in inside cylinder may also be operated to hold latch bolt in retracted position. Deadlocking latch.
PRIVATE ENTRANCE DOOR LOCK	X 361 DL	X 362 DL	X 360 DL				Latch bolt by key from outside knob and by knob inside, except when inside knob is locked by key in inside cylinder. Outside knob is always rigid. Cylinder in inside knob locks or unlocks inside knob. Deadlocking latch.
STORE DOOR LOCK	X 371 DL	X 372 DL	X 370 DL				Latch bolt by knob from either side, except when both knobs are locked by key in either cylinder. Cylinder in either knob locks or unlocks both knobs. Deadlocking latch.
ENTRANCE, OFFICE BLDG. OR LAVATORY DOOR LOCK	X 381 DL	X 382 DL	X 380 DL				Latch bolt by knob from either side, except when outside knob is locked by key in inside cylinder. Latch bolt may be retracted by key in outside cylinder or by knob from inside when outside knob is locked. Deadlocking latch.
COMMUNICATING DOOR LOCK	X 391 DL	X 392 DL	X 390 DL				Latch bolt by knob from either side, except when knobs are locked by key in either cylinder. Each cylinder locks or unlocks its own knob. Deadlocking latch.
COMMUNICATING DOOR LOCK	X 401 DL	X 402 DL	X 400 DL				Latch bolt by knob from either side, except when knobs are locked by key in either cylinder. Each cylinder locks or unlocks opposite knob. Deadlocking latch. (Note: This lock should not be used on rooms to which there is no other entrance.)
KNOB LOCK (RIGID KNOBS)	X 411 DL	X 412 DL	X 410 DL				Both knobs are rigid at all times. Key in either cylinder retracts latch bolt. Deadlocking latch.
STORE DOOR LOCK WITH LATCH HOLD BACK FEATURE	X 421 DL	X 422 DL	X 420 DL				Latch bolt by knob from either side, except when both knobs are locked by key in inside cylinder. Key in outside cylinder retracts latch bolt when outside knob is locked. Key in inside cylinder may also be operated to hold latch bolt in retracted position. Deadlocking latch.
HOTEL AND MOTEL GUEST ROOM DOOR LOCK	X 431 DL	X 432 DL	X 430 DL				Latch bolt by inside knob at all times. Outside knob always rigid. Latch bolt by guest key and master key in outside cylinder, except when key in inside cylinder is operated, thus shutting out all keys except emergency key. Operating key in inside cylinder operates visual indicator on the face of the outside knob, showing that room is occupied. Latch bolt by emergency key in outside cylinder at all times. Deadlocking latch.

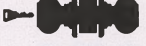
NOTE: DL AFTER A CATALOG NUMBER INDICATES "DEADLOCKING LATCH" IN ABOVE CHART.

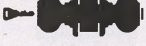
TYPE OF LOCK	2 3/4" BACKSET	5" BACKSET	2 3/8" BACKSET	KNOB OUTSIDE	LOCK SILHOUETTE	KNOB INSIDE	OPERATION
HOTEL AND MOTEL GUEST ROOM DOOR LOCK	X 441 DL	X 442 DL	X 440 DL				Latch bolt by inside knob at all times. Outside knob always rigid. Latch bolt by guest key and master key in outside cylinder, except when key in inside cylinder is operated, thus shutting out all keys except emergency key. Operating key in inside cylinder operates visual indicator on the face of the outside knob, showing that room is occupied. Turning inside knob or closing door automatically releases indicator and shut-out feature. Latch bolt by emergency key in outside cylinder at all times. Emergency key may also be operated in outside cylinder to make the shut-out feature effective; emergency key must then be used to release shut-out feature. Deadlocking latch.
HOTEL & MOTEL GUEST ROOM DOOR LOCK	X 451 DL	X 452 DL	X 450 DL				Latch bolt by inside knob at all times. Outside knob always rigid. Latch bolt by guest key and master key in outside cylinder, except when locking button in inside knob is operated, thus shutting out all keys except emergency key. Operating the locking button operates visual indicator on the face of the outside knob showing that room is occupied. Turning inside knob or closing door automatically releases indicator and shut-out feature. Latch bolt by emergency key in outside cylinder at all times. Emergency key may also be operated in outside cylinder to make the shut-out feature effective; emergency key must then be used to release shut-out feature. Deadlocking latch.
HOTEL & MOTEL GUEST ROOM DOOR LOCK	X 461 DL	X 462 DL	X 460 DL				Latch bolt by inside knob at all times. Latch bolt by outside knob, except when outside knob is locked by key in outside cylinder or locking button in inside knob. Outside knob unlocked by guest key or master key except when locking button in inside knob is operated, thus shutting out all keys except emergency key. Operating the locking button operates visual indicator on the face of the outside knob showing that room is occupied. Turning inside knob or closing door automatically releases indicator and shut-out feature. Latch bolt by emergency key in outside cylinder at all times. Deadlocking latch.
HOTEL & MOTEL GUEST ROOM DOOR LOCK	X 481 DL	X 482 DL	X 480 DL				Latch bolt by inside knob at all times. Outside knob always rigid. Latch bolt by guest key and master key in outside cylinder except when locking button in inside knob is operated, thus shutting out all keys except emergency key. Operating the locking button operates visual occupancy indicator on the face of the outside knob showing that room is occupied. Turning inside knob or closing door automatically releases indicator and shut-out feature. Latch bolt by emergency key in outside cylinder at all times. Deadlocking latch.
PUBLIC ENTRANCE DOOR LOCK WITH LATCH HOLD BACK FEATURE	X 491 DL	X 492 DL	X 490 DL				Latch bolt by knob from either side, except when outside knob is locked by locking button in inside knob. Inside knob always free. Latch bolt may be retracted by turning key or rotating inside knob, when outside knob is locked. Locking button must be manually returned to unlocked position to release outside knob. Locking button may also be operated to hold latch bolt in retracted position. Deadlocking latch.

NOTE: DL AFTER A CATALOG NUMBER INDICATES "DEADLOCKING LATCH" IN ABOVE CHART.

TYPE OF LOCK	2 3/4" BACKSET	5" BACKSET	2 3/8" BACKSET	KNOB OUTSIDE	LOCK SILHOUETTE	KNOB INSIDE	OPERATION
FRONT OR OFFICE DOOR LOCK	X 501 DL	X 502 DL	X 500 DL				Latch bolt by knob from either side, except when outside knob is locked by locking button in inside knob. Inside knob always free. Turning inside knob or key automatically releases locking button and outside knob. Closing door does not release locking button or outside knob. Deadlocking latch.
FRONT OR OFFICE DOOR LOCK	X 521 DL	X 522 DL	X 520 DL				Latch bolt by knob from either side, except when outside knob is locked by locking button in inside knob. Inside knob always free. When outside knob is locked, latch bolt may be retracted by turning key or rotating inside knob. Locking button must be manually returned to unlocked position to release outside knob. Deadlocking latch.
SERVICE STATION DOOR LOCK	X 531 DL	X 532 DL	X 530 DL				Latch bolt by knob from either side, except when outside knob is locked by locking button in inside knob. Inside knob always free. When outside knob is locked, latch bolt may be retracted by turning key or rotating inside knob. Turning key, rotating inside knob or closing door automatically releases locking button and outside knob, except when locking button has been rotated to a position which keeps the outside knob locked at all times. Deadlocking latch.
COMMUNICATING SUITE DOOR LOCK	X 541 DL	X 542 DL	X 540 DL				Latch bolt by knob from either side, except when outside knob is locked by locking button in inside knob or both knobs are locked by key in outside cylinder. Key locks or unlocks both knobs, and also releases locking button. Rotating inside knob or closing door automatically releases locking button when outside knob is locked by locking button. Deadlocking latch.
ALL PURPOSE DOOR LOCK	X 551 DL	X 552 DL	X 550 DL				Latch bolt by knob from either side, except when outside knob is locked by locking button in inside knob. Inside knob always free. Turning key or rotating inside knob automatically releases locking button and outside knob. Latch bolt by key in outside cylinder when locking button has been rotated to a position which keeps the outside knob locked at all times. Deadlocking latch.
CLASSROOM DOOR LOCK	X 561 DL	X 562 DL	X 560 DL				Latch bolt by knob from either side, except when outside knob is locked by key in cylinder of outside knob. Inside knob is always free. Deadlocking latch.
PUBLIC REST ROOM OR DORMITORY BEDROOM DOOR LOCK	X 571 DL	X 572 DL	X 570 DL				Latch bolt by knob from either side, except when outside knob is locked by locking button in inside knob. Rotating inside knob or closing door automatically releases locking button and outside knob. Key in outside cylinder locks or unlocks outside knob. Key may also be used to release locking button. Deadlocking latch.
STOREROOM OR EXIT DOOR LOCK	X 581 DL	X 582 DL	X 580 DL				Latch bolt by key from outside and by knob inside. Outside knob always rigid. Inside knob is always free. Deadlocking latch.

NOTE: DL AFTER A CATALOG NUMBER INDICATES "DEADLOCKING LATCH" IN ABOVE CHART.

DUMMY KNOBS

DUMMY KNOB, SINGLE	X12 IF DUMMY CYLINDER PLUG IS DESIRED, SPECIFY X52	NON-ROTATABLE SINGLE DUMMY KNOB. SURFACE APPLIED WITH WOOD SCREWS.
DUMMY KNOBS, PAIR	X18 IF DUMMY CYLINDER PLUGS ARE DESIRED, SPECIFY X53	NON-ROTATABLE PAIR OF DUMMY KNOBS. SCREW ROSES FIRMLY CLAMP SET TO DOOR.

EXTRA HEAVY DUTY KNOBS AND ROSES

Knobs and roses with wall thicknesses of .080" are available on all "X" Series Locks when specified.

STAINLESS STEEL EXTERIOR TRIM

"X" Series Locks can be furnished with .050" thick 18-8 stainless steel knobs, roses, latch face, and strike. Specify US 32 or US 32D.

STAINLESS STEEL MECHANISM

For marine use or installations where extreme climatic conditions exist, "X" Series Locks may be ordered with mechanism parts made of 18-8 stainless steel or "Delrin." Specify by adding "W/SM" to lock number.

LEVER HANDLES

Lever handles may be substituted for knobs. Specify by adding "W/Lever handles," to lock number.

THICK DOORS

All regular "X" Series Locks will accommodate doors from 1 $\frac{3}{8}$ " to 2" thick. Special locks may be ordered for doors from 2" to 3" thick (specify exact door thickness).

INSTRUCTION PLATES

Instruction plates are available for all hotel and motel guest room door locks. When ordering locks, request instruction plates if desired.



FALCON HEAVY DUTY LOCKS

There is a complete range of Falcon lock styles, finishes, and functions to satisfy every builder requirement. All exterior parts of Falcon Locks are manufactured from pure brass or bronze, thus assuring the owner of years of lasting beauty and trouble-free service. All internal mechanism parts, subject to greatest stress and wear, are made of double treated, rust-resistant steel. Springs are made of stainless steel and beryllium copper for maximum strength.

The Key-in-Knob lock in Crown Royal styling is effectively complimented in solid brass. A striking addition to any exterior door.

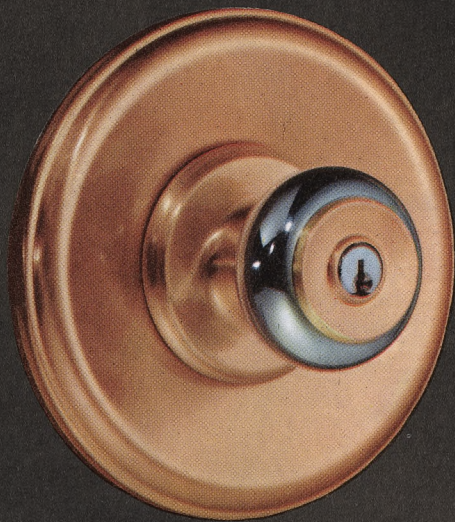

The brilliance and sparkle of bright chrome and satin bronze adds life and beauty to this combination of a Key-in-Knob Entrance lock in Crown Royal style with the No. 1642 Round Escutcheon.

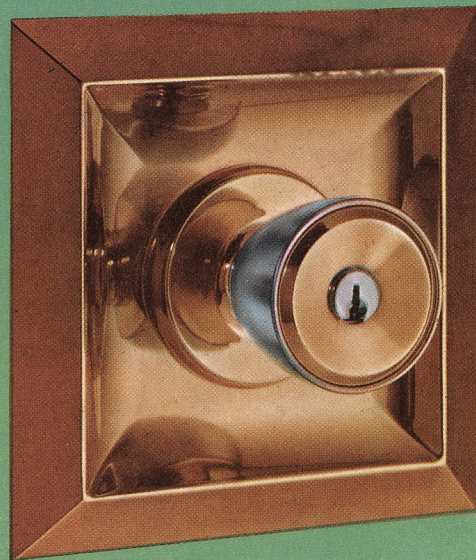

The modern styling of the Beverly knob is popular with admirers of the contemporary. Shown here is a Key-in-Knob lock in a multiple color combination of satin chrome and bright bronze.

FALCON "E" SERIES LOCKS

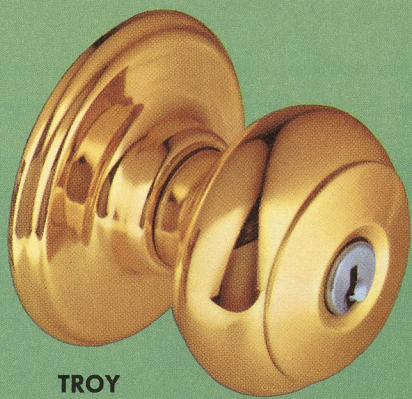

TROY

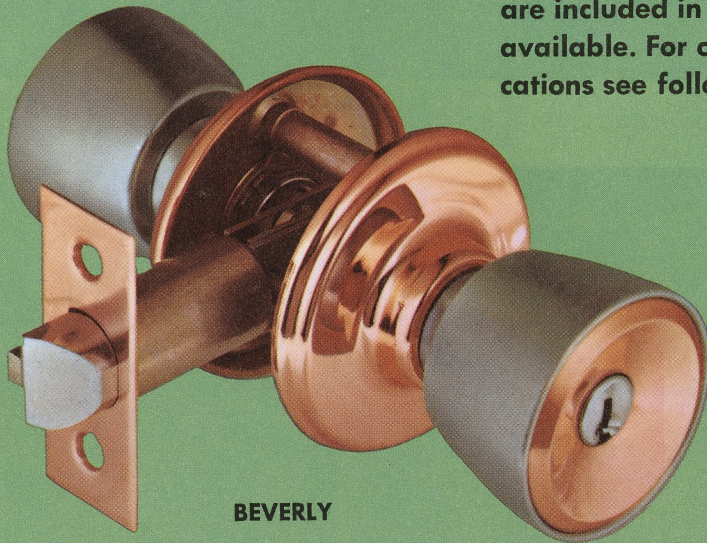

BEVERLY

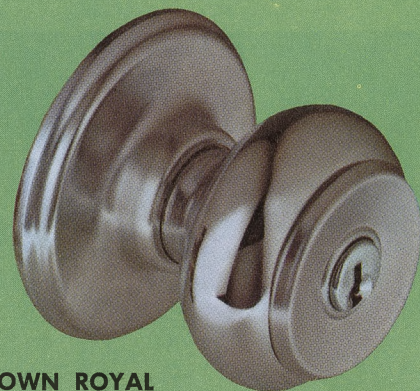

CROWN ROYAL

Falcon "E" series Heavy Duty locks feature a heavy duty, four-post construction which provides a telescoping precision alignment between the two knob assemblies and automatic adjustment to door thickness. They are available in three knob styles as shown and in single or double cylinder keyed locks, in a variety of functions. In addition, passage sets, privacy locks and keyless exit door latches are included in the "E" series. Locks for thicker doors are available. For complete list of lock functions and specifications see following pages.

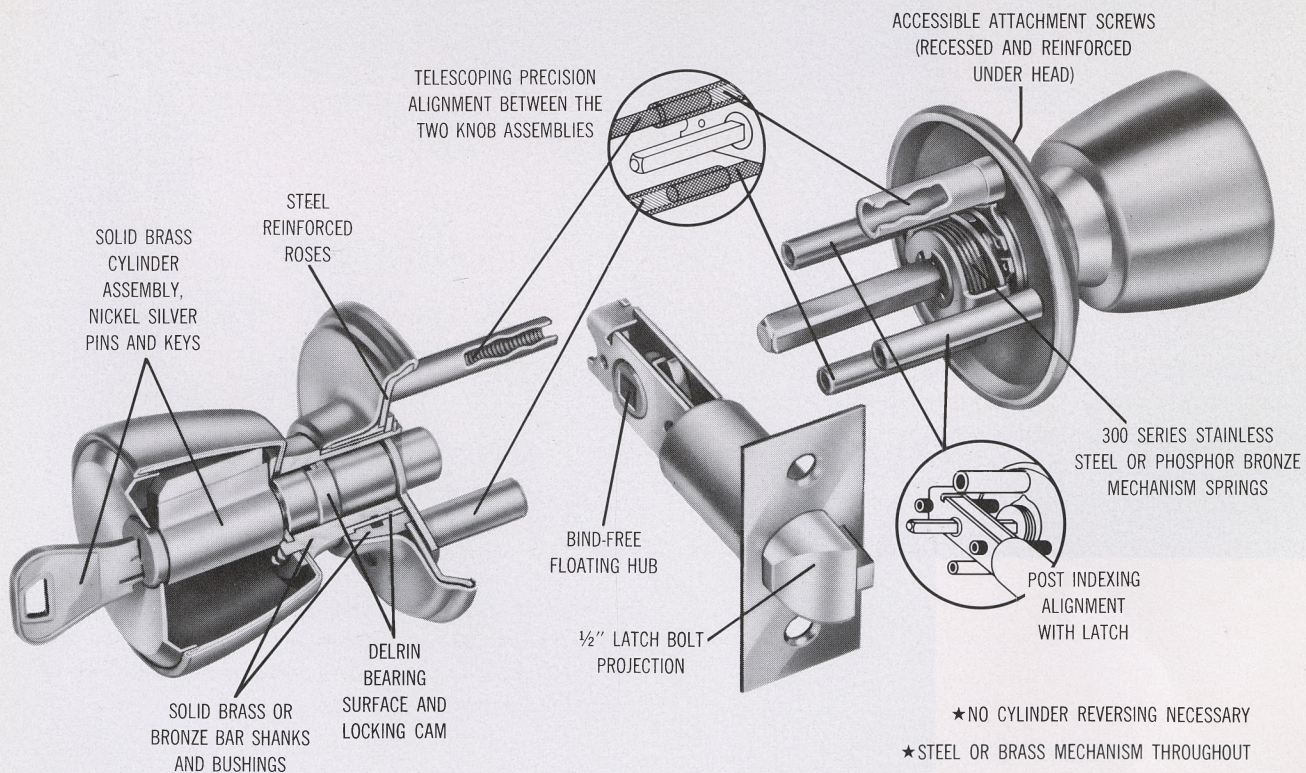

































LOCK SELECTOR

The lock selector chart below provides a convenient guide to the correct lock function for any door. It will aid in selecting the locks necessary for proper security and convenience of door openings in all commercial buildings.

- **PLAIN KNOB**
No locking mechanism.
- ⊙ **PUSH BUTTON**
Button pushed inward locks door. Turn of inside knob releases button — unlocks door.
- ⊕ **TURN BUTTON**
Quarter turn to left locks door. Turning button to the right unlocks door.
- ⓪ **EMERGENCY RELEASE**
Provides privacy, but in emergency can be opened without special key.
- Ⓛ **PIN TUMBLER KEY UNIT**
Provides unlimited key changes. Can be master-keyed, and grand-mastered as desired.
- Ⓜ **INDICATOR KEYWAY**
Pin tumbler keyway with visual Occupancy Indicator pin.

TYPE OF LOCK	2 3/8" BACKSET	2 3/4" BACKSET	5" BACKSET	KNOB OUTSIDE	LOCK SILHOUETTE	KNOB INSIDE	OPERATION
PASSAGE LATCHSET	E 100	E 101	E 102	○		○	Latch bolt by knob from either side. Both knobs always free.
EXIT DOOR LATCHSET	E 140 DL	E 141 DL	E 142 DL	○		○	Latch bolt by inside knob only. Outside knob always rigid. Deadlocking latch.
CONNECTING ROOM OR EXIT DOOR LATCHSET	E 160 DL	E 161 DL	E 162 DL	Blank plate		○	Latch bolt by inside knob at all times. Blank plate outside.
KEYLESS COMMUNICATING DOOR LOCK	E 210 DL	E 211 DL	E 212 DL	⊕		⊕	Latch bolt by knob from either side, except when locked by locking button in either knob. Each locking button locks both knobs. Both locking buttons must be manually returned to unlocked position to release knobs. Deadlocking latch.
KEYLESS EXIT DOOR LOCK	E 220 DL	E 221 DL	E 222 DL	○		⊕	Latch bolt by knob from either side, except when outside knob is locked by locking button in inside knob. Inside knob is always free. Locking button must be manually returned to unlocked position to release outside knob. Deadlocking latch.
KEYLESS EXIT DOOR LOCK	E 230 DL	E 231 DL	E 232 DL	○		⊕	Latch bolt by knob from either side, except when both knobs are locked by locking button in inside knob. Locking button must be manually returned to unlocked position to release both knobs. Deadlocking latch.
PRIVACY LOCK FOR BATH OR BEDROOM DOORS (PUSH BUTTON)	E 300	E 301	E 302	⓪		⊙	Latch bolt by knob from either side, except when outside knob is locked by locking button in inside knob. Emergency release in outside knob. Rotating inside knob automatically releases locking button and outside knob.
PRIVACY LOCK FOR BATH OR BEDROOM DOORS (TURN BUTTON)	E 330	E 331	E 332	⓪		⊕	Latch bolt by knob from either side, except when both knobs are locked by locking button in inside knob. Emergency release in outside knob. Locking button must be manually returned to unlocked position to release both knobs.
PRIVATE ENTRANCE DOOR LOCK	E 360 DL	E 361 DL	E 362 DL	Ⓛ		Ⓛ	Latch bolt by key from outside knob and by knob inside, except when inside knob is locked by key in inside cylinder. Outside knob is always rigid. Cylinder in inside knob locks or unlocks inside knob. Deadlocking latch.
STORE DOOR LOCK	E 370 DL	E 371 DL	E 372 DL	Ⓛ		Ⓛ	Latch bolt by knob from either side, except when both knobs are locked by key in either cylinder. Cylinder in either knob locks or unlocks both knobs. Deadlocking latch.

NOTE: DL AFTER A CATALOG NUMBER INDICATES "DEADLOCKING LATCH" IN ABOVE CHART.

TYPE OF LOCK	2 3/8" BACKSET	2 3/4" BACKSET	5" BACKSET	KNOB OUTSIDE	LOCK SILHOUETTE	KNOB INSIDE	OPERATION
ENTRANCE, OFFICE BLDG. OR LAVATORY DOOR LOCK	E 380 DL	E 381 DL	E 382 DL				Latch bolt by knob from either side, except when outside knob is locked by key in inside cylinder. Latch bolt may be retracted by key in outside cylinder or by knob from inside when outside knob is locked. Deadlocking latch.
COMMUNICATING DOOR LOCK	E 390 DL	E 391 DL	E 392 DL				Latch bolt by knob from either side, except when knobs are locked by key in either cylinder. Each cylinder locks or unlocks its own knob. Deadlocking latch.
KNOB LOCK	E 410 DL	E 411 DL	E 412 DL				Both knobs are rigid at all times. Key in either cylinder retracts latch bolt. Deadlocking latch.
HOTEL AND MOTEL GUEST ROOM DOOR LOCK	E 430 DL	E 431 DL	E 432 DL				Outside knob always rigid. Latch bolt by guest key or master key in outside cylinder and by inside knob, except when key is turned in inside knob, thus locking inside knob and shutting out all keys except emergency key in outside knob. Turning the key in inside knob also operates visual indicator on the face of the outside knob, showing that room is occupied. Removing key from inside knob automatically releases inside knob, visual indicator, and shut-out feature. Latch bolt by emergency key in outside cylinder at all times. Deadlocking latch.
HOTEL AND MOTEL GUEST ROOM DOOR LOCK	E 480 DL	E 481 DL	E 482 DL				Latch bolt by inside knob at all times. Outside knob always rigid. Latch bolt by guest key and master key in outside knob, except when locking button in inside knob is depressed (use end of key to push), thus shutting out all keys except emergency key. Depressing the locking button operates visual indicator on the face of the outside knob, thus showing that room is occupied. Turning inside knob automatically releases indicator and shut-out feature. Latch bolt by emergency key in outside knob at all times. Deadlocking latch.
FRONT OR OFFICE DOOR LOCK	E 500 DL	E 501 DL	E 502 DL				Latch bolt by knob from either side, except when outside knob is locked by locking button in inside knob. Inside knob always free. Turning inside knob or key automatically releases locking button and outside knob. Closing door does not release locking button or outside knob. Deadlocking latch.
FRONT OR OFFICE DOOR LOCK	E 520 DL	E 521 DL	E 522 DL				Latch bolt by knob from either side, except when outside knob is locked by locking button in inside knob. Inside knob always free. When outside knob is locked, latch bolt may be retracted by turning key or rotating inside knob. Locking button must be manually returned to unlocked position to release outside knob. Deadlocking latch.
ENTRANCE DOOR LOCK	E 530 DL	E 531 DL	E 532 DL				Latch bolt by knob from either side, except when both knobs are locked by locking button in inside knob. Turning key or manually returning locking button to unlocked position releases both knobs. Deadlocking latch.
CLASSROOM DOOR LOCK	E 560 DL	E 561 DL	E 562 DL				Latch bolt by knob from either side, except when outside knob is locked by key in cylinder of outside knob. Inside knob is always free. Deadlocking latch.
PUBLIC REST ROOM OR DORMITORY BEDROOM DOOR LOCK	E 570 DL	E 571 DL	E 572 DL				Latch bolt by knob from either side, except when outside knob is locked by locking button in inside knob. Key in outside knob locks or unlocks outside knob. Deadlocking latch.
STOREROOM OR EXIT DOOR LOCK	E 580 DL	E 581 DL	E 582 DL				Latch bolt by key from outside and by knob inside. Outside knob always rigid. Inside knob is always free. Deadlocking latch.

NOTE: DL AFTER A CATALOG NUMBER INDICATES "DEADLOCKING LATCH" IN ABOVE CHART.

INSTALLATION OF "X" AND "E" SERIES LOCKS

Side and latch hole preparations for all "X" and "E" Series locks, regardless of function, are the same. Two holes—a $2\frac{1}{8}$ " diameter side hole and a 1" diameter edge hole—are all that are required.

A complete line of installation tools, including boring jigs, mortise outline cutters for latch face and strike, strike locating tool, special drills and drill adapter are available for fast, precision installation. "X" Series locks will accommodate doors $1\frac{3}{8}$ " to 2". "E" Series locks will accommodate doors $1\frac{3}{8}$ " to $1\frac{3}{4}$ ". Special "X" and "E" Series locks may be ordered from the factory which will accommodate thicker doors.

All "X" and "E" Series locks are reversible and can be installed on either right or left hand doors, swinging in or out.

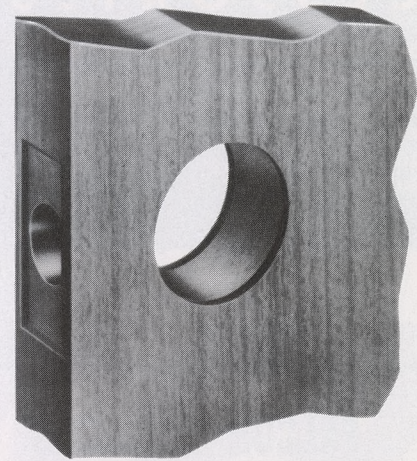

METAL DOOR INSTALLATION

SPECIFICATIONS FOR METAL DOORS AND/OR METAL FRAMES

"X" and "E" Series Locks are available with latches and strikes which have dimensions that permit their installation on metal doors and/or frames. When locks are ordered for use on metal doors or frames, the factory must be advised so that machine screws can be furnished with the latch or strike as required. ALSO, the BACKSET, LATCH FACE, AND STRIKE DIMENSIONS MUST BE SPECIFIED.

Stock metal doors and frames generally have standard lock and strike installation preparations as shown in the following illustrations:

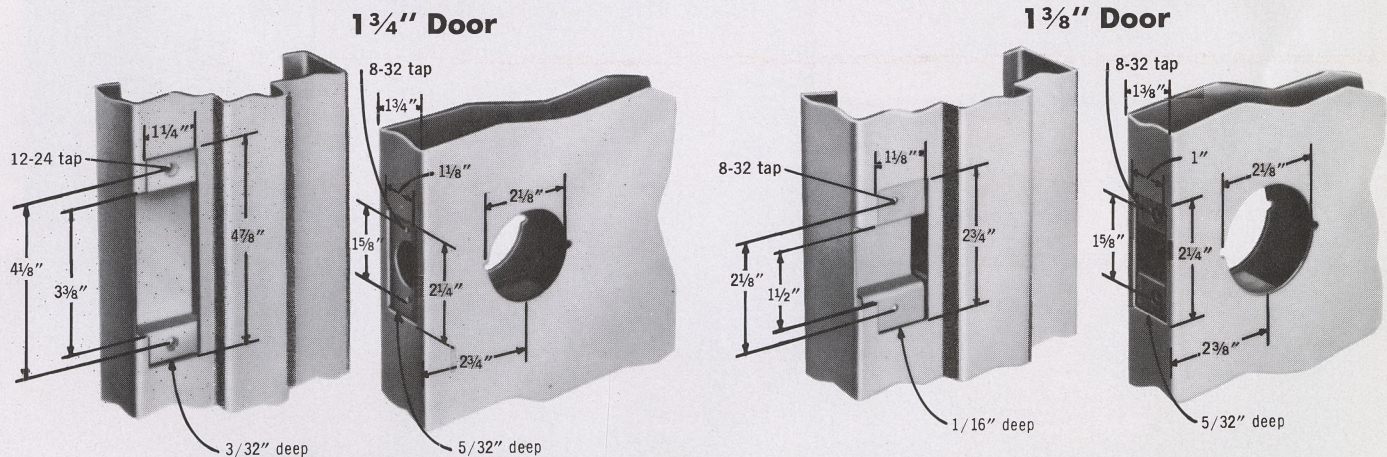

LOCK SPECIFICATIONS FOR STOCK 1 3/4" METAL DOORS AND FRAMES

BACKSET: $2\frac{3}{4}$ "

LATCH FACE: $2\frac{1}{4}$ " x $1\frac{1}{8}$ " x $5/32$ " thick.

STRIKE: $4\frac{7}{8}$ " x $1\frac{1}{4}$ " x $3/32$ " thick; or $2\frac{3}{4}$ " x $1\frac{1}{8}$ " x $3/32$ " thick (incl. dust box).

SCREWS: 8-32" x $3/8$ " undercut head machine screws.
12-24" x $1/2$ " undercut head machine screws.

LOCK SPECIFICATIONS FOR STOCK 1 3/8" METAL DOORS AND FRAMES

BACKSET: $2\frac{3}{8}$ "

LATCH FACE: $2\frac{1}{4}$ " x 1" x $5/32$ " thick.

STRIKE: $2\frac{3}{4}$ " x $1\frac{1}{8}$ " x $3/32$ " thick (incl. dust box).

SCREWS: 8-32" x $3/8$ " undercut head machine screws.

FALCON

ACCESSORIES

In addition to the complete range of keyed entrance locks, keyed locks and passage sets, Falcon also manufactures many auxiliary locks and related items to provide the architect and builder with a complete selection of quality door hardware.

FALCON PADLOCKS

No. 955 . . . A pin tumbler padlock manufactured from solid bar stock brass with chrome plated, case-hardened steel shackle. The entire cylinder assembly is removable for easier rekeying or quick cylinder change.

(also available)

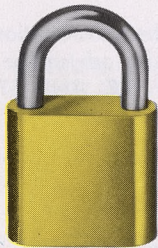

No. 955 X

Padlock with 9" bronze chain.

No. 955 DL

Deadlocking type padlock.

No. 955 DLX

Deadlocking type padlock with 9" bronze chain.

(Padlocks with brass, or with longer brass or steel shackles are also available.)

AUXILIARY LOCKS

No. 820DL Cylinder Spring Latch
(Blank Plate Inside)

No. 840DL Cylinder Spring Latch

No. 910 School House Safety
Deadlock

No. 920 Cylinder Deadlock (Blank
Plate Inside)

No. 930 Double Cylinder Deadlock

No. 940 Cylinder Deadlock

No. 960 Dead Bolt

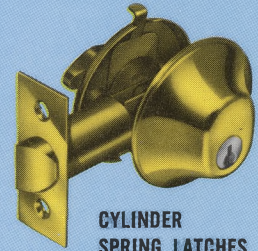

CYLINDER
SPRING LATCHES

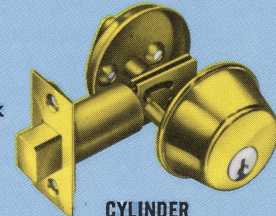

CYLINDER
DEADLOCKS

AUXILIARY CYLINDERS

No. 934 1" long

No. 935 1 1/8" long

No. 936 1 1/4" long

No. 937 1 3/8" long

No. 938 1 1/2" long

No. 950 Rim Lock Cylinder

No. 951 Rim Lock Cylinder

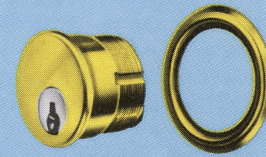

THREADED
CYLINDERS

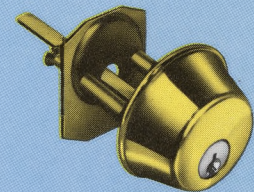

RIM CYLINDERS

For additional technical information, sources of supply and prices,
contact your local distributor or write to:

FALCON LOCK CO.

8609 SAN VINCENTE AVENUE • SOUTH GATE, CALIFORNIA